

# Data Sheet

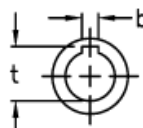

Article number: 2301077421  
Description: E+G Handwheel  
VR.160 FP+I

## Measures

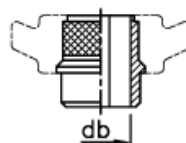
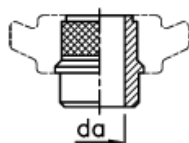
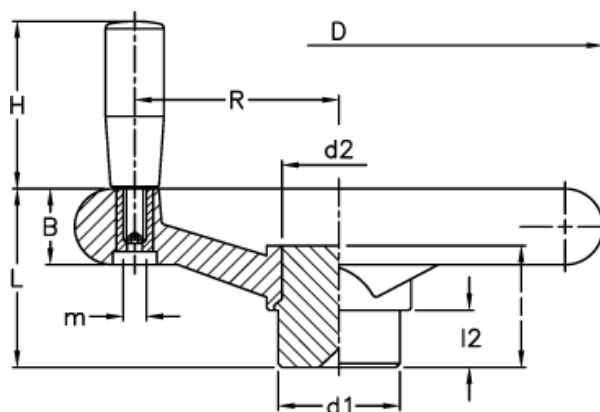

da max tilladelig boring uden not

db max tilladelig boring med not

b	= 5	H	= 65
B	= 22	l	= 38
C (N m)	= 165	L	= 50
D	= 157	L (J)	= 12
d1	= 32	l2	= 15
d2	= 24	m	= M8
da	= 20	R	= 59
db	= 16	t	= 18.3